



# BX1752

## 2022-2023 Chevy Traverse (Includes ACC & Top Shutters) (No Lower Shutters) Installation Instructions

**Attachment Tab Height: 14.5"**

**Attachment Tab Width: 25"**

**Serial Number**

**Please read BOTH these Installation Instructions and the General Information sheet prior to installing or operating this equipment.**

- Blue Ox® towing products and accessories are intended to be installed by Blue Ox® Dealers who are familiar with our products and have the equipment and knowledge necessary to do "fit work". If needed, Blue Ox® Dealers can be found at [www.blueox.com](http://www.blueox.com) or by contacting our Technical Service Department at (402) 385-3051.
- Many Blue Ox® baseplates are designed to use existing holes and hardware to mount the baseplate to the towed vehicle. Even though bolts are there, do not assume they are adequate for baseplate mounting. Always use the hardware supplied in the hardware kit and existing hardware as specified in the installation instructions.

**Bolt Torque Specifications**  
Torque in Foot-Pounds for Inch Bolts

Bolt Size	Grade 5	Grade 8
1/4"	10	14
5/16"	19	29
3/8"	33	47
7/16"	54	78
1/2"	78	119
5/8"	154	230
3/4"	257	380



If the front of your vehicle looks different than this, please contact us at (402)385-3051.

**Bolt Torque Specifications**  
Torque in Foot-Pounds for Metric Bolts

Bolt Size	Grade 8.8	Grade 10.9
6MM	6	8
8MM	16	22
10MM	31	40
12MM	54	70
14MM	89	117
16MM	161	230
18MM	222	318

**Reference your vehicle owner's manual for manufacturer's towing specifications.**

**! WARNING**

Failure to read and follow these instructions could result in separation of the towed vehicle from the tow bar, causing property damage, loss of towed vehicle, personal injury or death.

BX1752  
2022-2023 Chevy Traverse  
(Includes Adaptive Cruise Control & Top Shutters) (No Lower Shutters)  
Installation Instructions

**Instruction Notes:** The fascia, fascia cover, Adaptive Cruise Control Bracket and windshield washer fluid reservoir are removed and reinstalled for the baseplate installation. Some drilling and trimming is required.

Place all components that are removed on a flat, sturdy surface. All items will be reinstalled unless otherwise noted after the baseplate is installed.

The dimensional variations between otherwise identical vehicles can be considerable. While the baseplate was designed for easy installation, it may be necessary to tailor the baseplate slightly to compensate for vehicle manufacturer's tolerances.

The BX8848 Tail Light Wiring Kit is recommended for this vehicle.

## ***NOTICE***

- Handling of some cosmetic parts when installing this product may require the use of protective covers, rags, specialty tools, etc. to prevent damage.
- When using power drills be aware of the dangers of torque and drill bit length.
- When using a reciprocating saw be aware of objects behind the cutting surface.
- Use a good quality paint to spray cut edges of frame to prevent rusting.
- Be sure that **ALL** electrical connections are plugged in and accessories are functioning properly before reinstalling the fascia.
- The baseplate is computer tested to your vehicle's GVWR, exceeding this weight will void the manufacturer's warranty.
- Be sure to use a sufficient amount of Loctite® Red on all bolt threads before tightening. Tighten all bolts according to the torque chart provided unless specified.
- Dealer or installer be certain the user receives these instruction sheets.
- If the baseplate is in an accident, it must be replaced. **DO NOT** use it again! An accident can cause unseen damage and using it again could result in more damage or serious injury. **DO NOT** use the baseplate if it is damaged or missing parts.

BX1752  
 2022-2023 Chevy Traverse  
 (Includes Adaptive Cruise Control & Top Shutters) (No Lower Shutters)  
 Installation Instructions

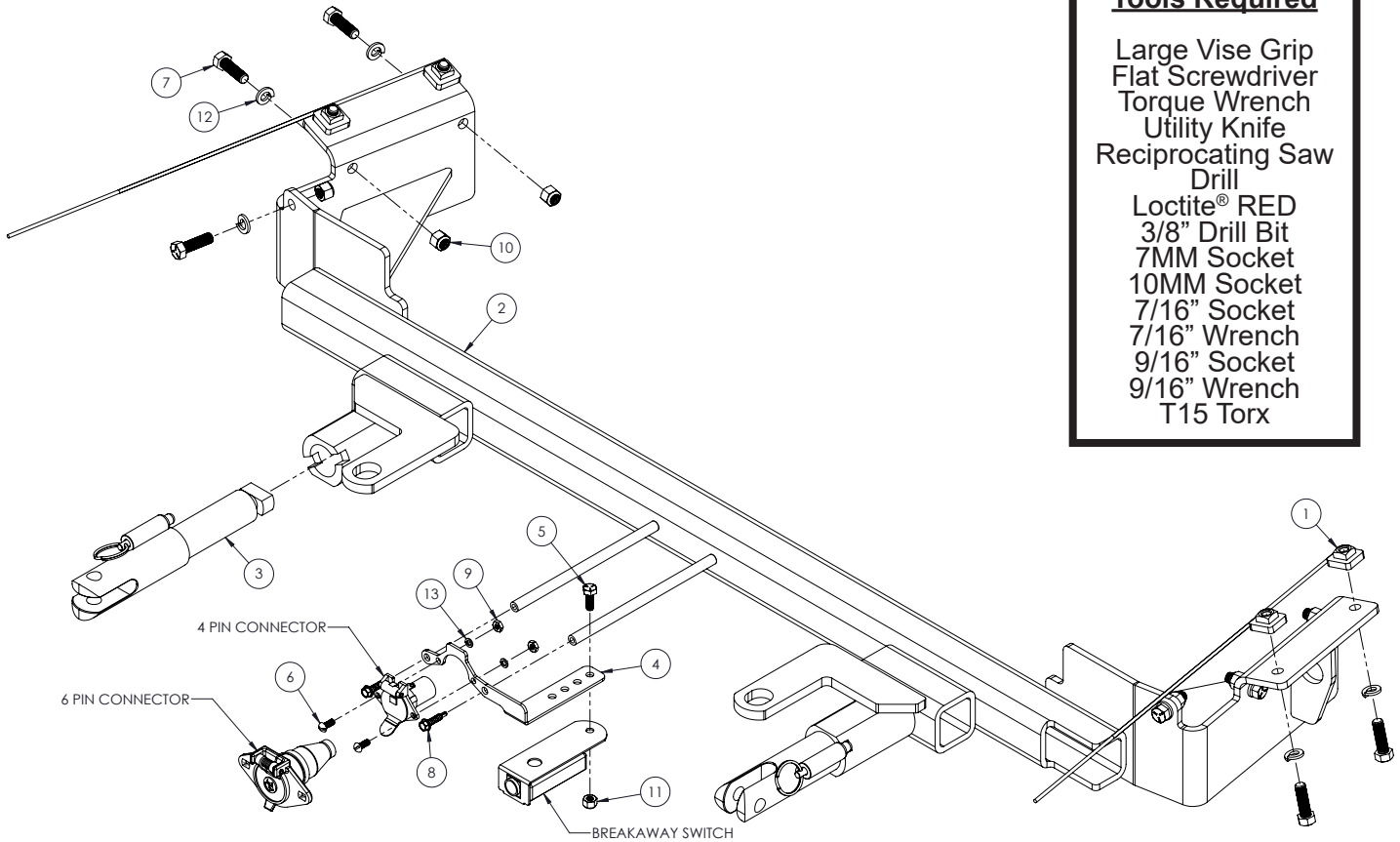

- Tools Required**
- Large Vise Grip
  - Flat Screwdriver
  - Torque Wrench
  - Utility Knife
  - Reciprocating Saw
  - Drill
  - Loctite® RED
  - 3/8" Drill Bit
  - 7MM Socket
  - 10MM Socket
  - 7/16" Socket
  - 7/16" Wrench
  - 9/16" Socket
  - 9/16" Wrench
  - T15 Torx

Item No.	Part No.	Description	Qty.
1.....	61-5208 .....	3/8" Nut Plate w/ 14" Wire .....	4
2.....	61-8544 .....	BX1752 Baseplate.....	1
3.....	62-3469 .....	Attachment Tab Assembly with Hole .....	2
4.....	101-9381 .....	Electrical Bracket with Breakaway Switch Mount.....	1
5.....	201-0050 .....	1/4"-20 x 3/4" Hex Head Bolt, Grade 5, ZP .....	1
6.....	201-0192 .....	#10-32 1/2" Round Slotted Head Screw.....	2
7.....	201-0368 .....	3/8"-16 x 1-1/4" Hex Head Bolt, Grade 5, ZP .....	10
8.....	201-0979 .....	#12-14 x 1" Self Drilling Screw, ZP.....	2
9.....	202-0047 .....	#10-32 Hex Nut .....	2
10.....	202-0090 .....	3/8"-16 Hex Nylon Insert Lock Nut, ZP.....	6
11.....	202-0102 .....	1/4"-20 Hex Nylon Nut, ZP .....	1
12.....	203-0010 .....	3/8" Lock Washer, ZP .....	10
13.....	203-0054 .....	#10 Lock Washer, ZP .....	2
14.....	226-0049(not shown) .....	Class IV Safety Cables.....	2
15.....	229-0512(not shown) .....	1/2" Quicklink, ZP .....	2
16.....	290-0437(not shown) .....	Black Cap Plug Receiver.....	2

**Important:**

Use only genuine factory replacement parts on your baseplate. Do **NOT** substitute homemade or non-typical parts. If a bolt is lost or in need of replacement, for your safety and the preservation of your baseplate, be sure to use a replacement bolt of the same grade (In most cases it will be Grade 5, please reference the parts list above). Replacement parts may be ordered through your nearest Blue Ox® Dealer or Distributor. Failing to follow and/or altering these installation instructions in either installation or required equipment will void the manufacturer's warranty. Towing behind a non-motorized vehicle will void the warranty.

**Tail Light Removal Instructions** Installation Instructions



1. Unpop the covers for the five (5) bolts on the back panel of the vehicle. Then using a 7MM socket, remove the four (4) top bolts (white) and use a T20 Torx to remove the one (1) bottom bolt (gray). Do this on both sides of the vehicle.



2. Grab the wheel well trim behind the rear tire and pop out the trim past the side and rear panel joint. Keep trim propped away from panels. Then using a 7MM socket remove the one (1) bolt under the trim. Do this on both sides of the vehicle.



3. Using a T15 Torx, remove the four (4) bolts from the wheel well behind the rear tire. Do this on both sides of the vehicle.



4. Grab the rear panel behind the tire and pull away from the vehicle all the way under the tail light. Do not fully remove panel. Remove tail light and install tail light wiring kit. Once installation is complete, reinstall all items. Do this on both sides of the vehicle.



BX1752  
2022-2023 Chevy Traverse  
(Includes Adaptive Cruise Control & Top Shutters) (No Lower Shutters)  
Installation Instructions

**Fascia Removal and Baseplate Installation Instructions**

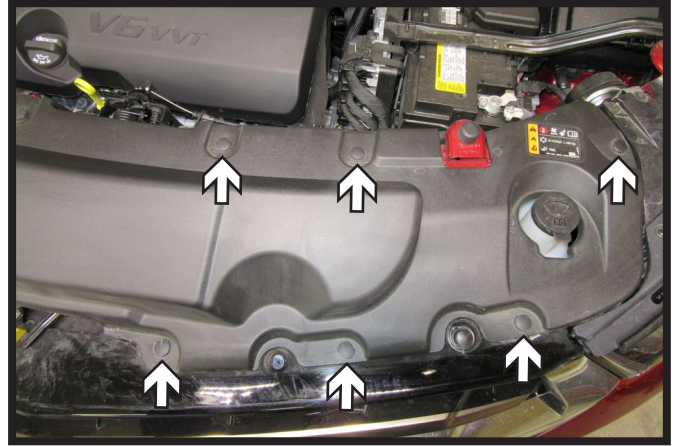
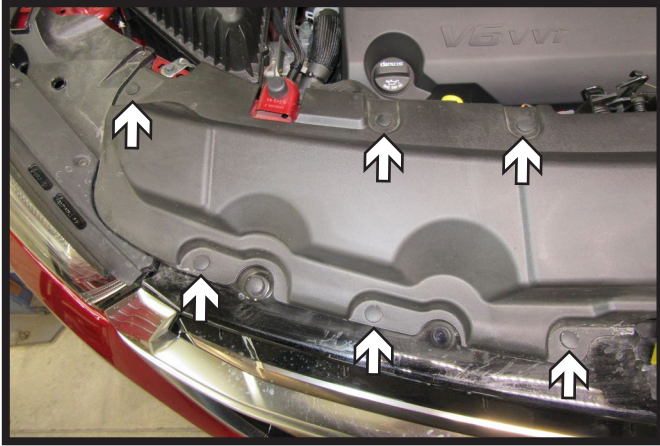

1. Remove the twelve (12) push pins from the fascia cover on the top of the vehicle. There are six (6) push pins on each side of the vehicle. Remove fascia cover and set aside to be reinstalled later.

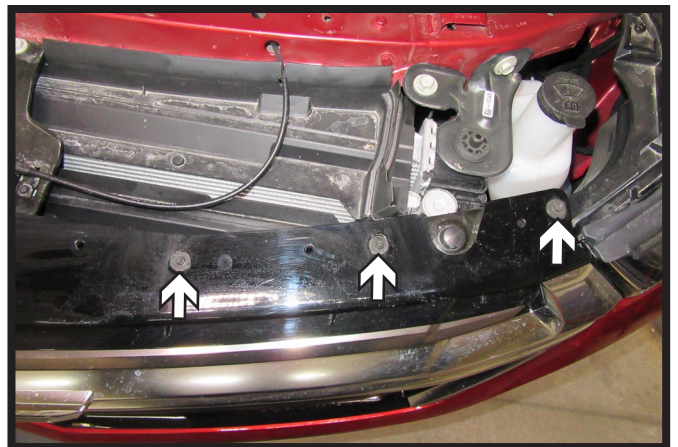
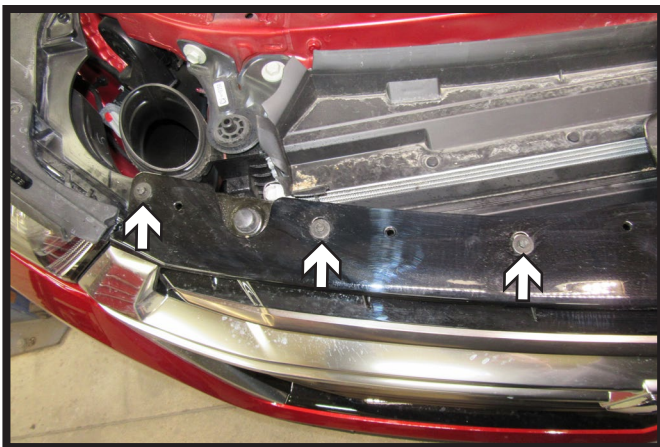

2. Using a 7MM socket, remove the six (6) bolts, three (3) on each side, from the top of the fascia.

BX1752  
2022-2023 Chevy Traverse  
(Includes Adaptive Cruise Control & Top Shuttters) (No Lower Shuttters)  
Installation Instructions



3. Using a T15 Torx, remove the five (5) bolts along the edge of the wheel well. Do this on both sides of the vehicle.

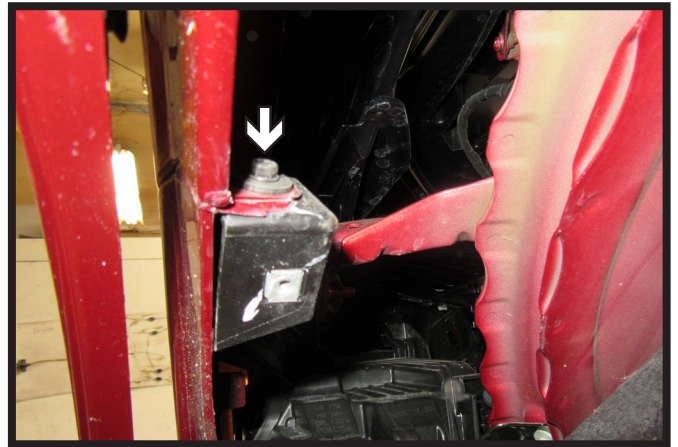

4. Pull back the wheel well liner. Using a 7MM socket, remove the one (1) bolt from the fascia joint. Do this on both sides of the vehicle.

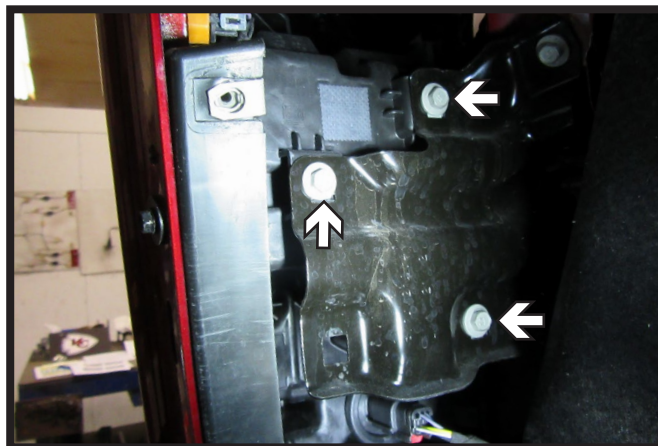

5. Pull back the wheel well liner. Using a 10MM socket, remove the three (3) bolts behind the running lights. Do this on both sides of the vehicle.



BX1752  
2022-2023 Chevy Traverse  
(Includes Adaptive Cruise Control & Top Shutters) (No Lower Shutters)  
Installation Instructions

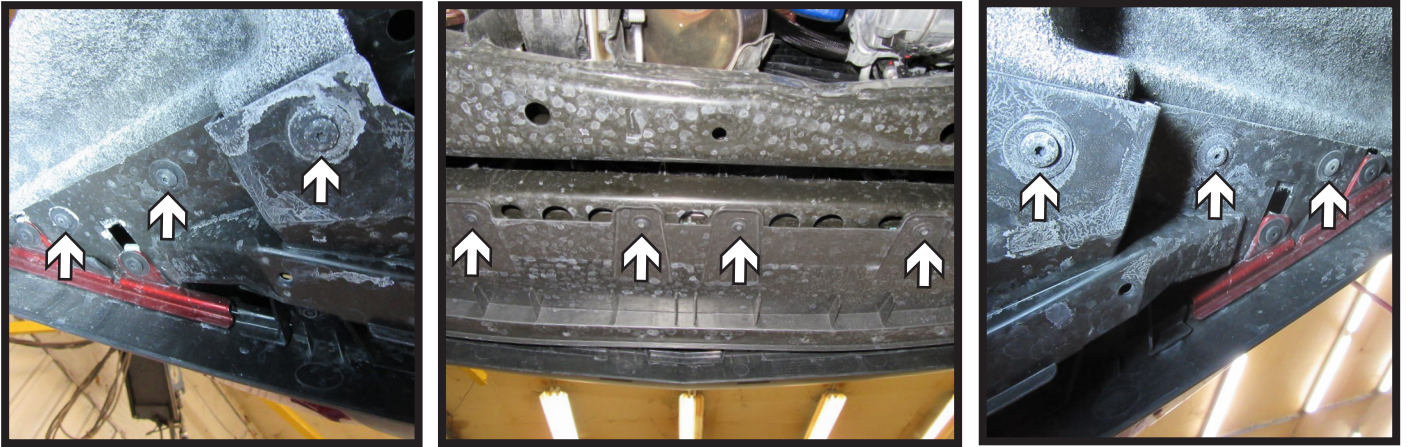

6. Using a T15 Torx, remove the ten (10) bolts from the underside of the fascia. There are three (3) on each side and four (4) in the middle.

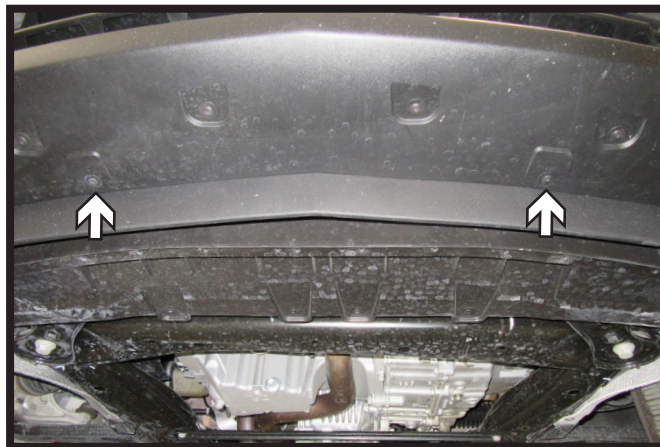

7. Using a T15 Torx, remove the two (2) bolts from the underside of the fascia.

BX1752  
2022-2023 Chevy Traverse  
(Includes Adaptive Cruise Control & Top Shutters) (No Lower Shutters)  
Installation Instructions



8. Start to remove the fascia. As the fascia is removed unplug the three (3) electrical connections passenger side (white) and one (1) on the driver side (gray) of the vehicle. Remove fascia and set aside to be reinstalled later.

**Note:** Unplug the temperature sensor on the passenger side by pressing down on the red button and then pulling down on the handle to disconnect plug from sensor.

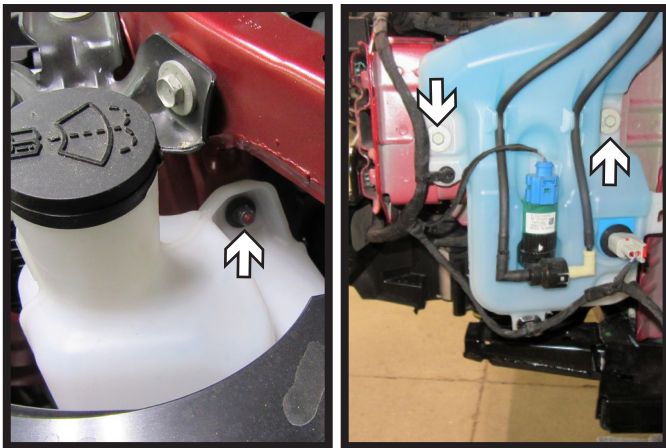

9. On the driver side of the vehicle, using a 10MM socket, remove the one (1) nut from the top of the windshield washer fluid reservoir. Disconnect all lines. Then using a 10MM socket, remove the two (2) bolts at the bottom of the reservoir. Set aside to be reinstalled later.

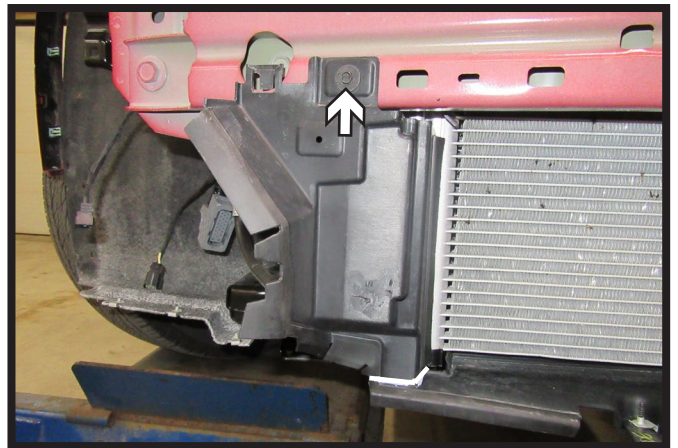

10. Using a 7MM socket, remove the two (2) bolts, one (1) on each side from the top of shroud. Using a utility knife remove the side pieces of the shroud as indicated.



BX1752  
2022-2023 Chevy Traverse  
(Includes Adaptive Cruise Control & Top Shutters) (No Lower Shutters)  
Installation Instructions

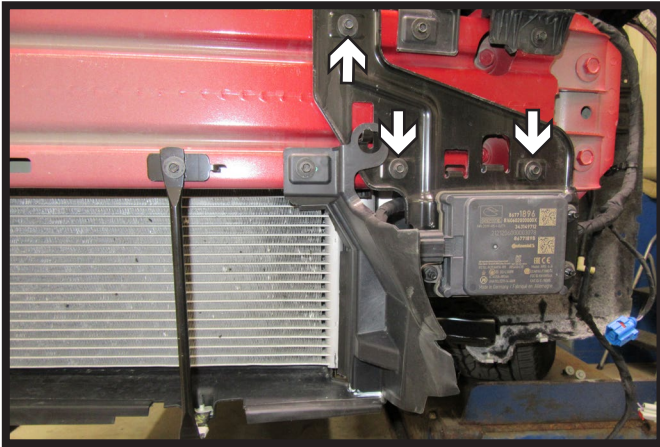

11. Using a 7MM socket, remove the three (3) bolts from the Adaptive Cruise Control bracket on the driver side of the vehicle. Let the ACC bracket hang to be reinstalled later.

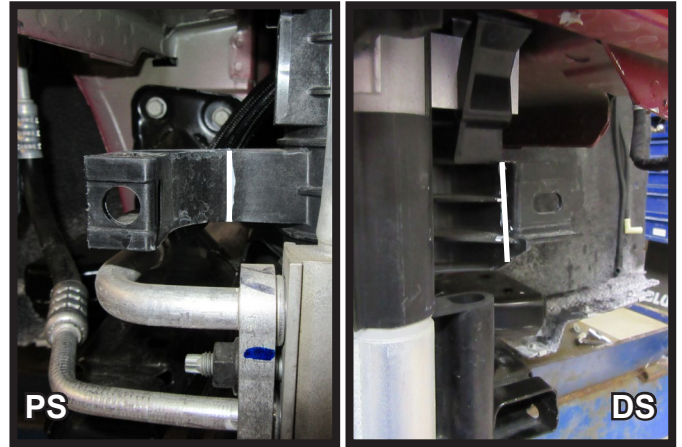

12. Using a reciprocating saw, trim the brackets on the driver and passenger sides of the vehicle as indicated to allow clearance for the baseplate.

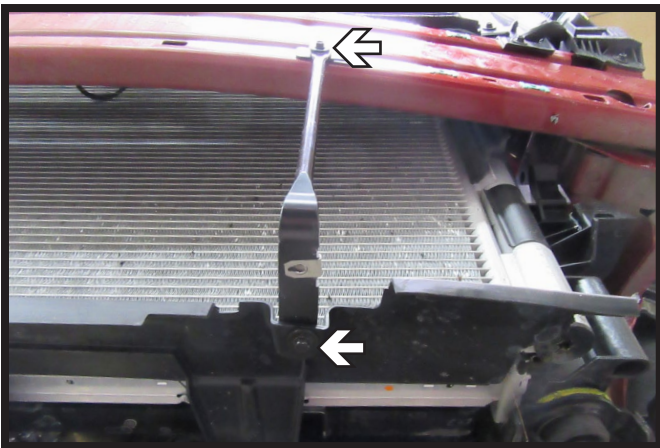

13. Using a 7MM socket, remove the two (2) bolts from the metal bracket on the front of the vehicle. Do this on both sides of the vehicle. These will be reinstalled later.

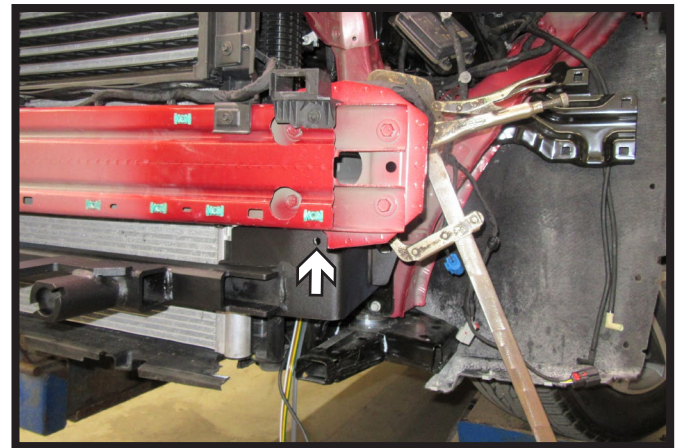

14. Slide baseplate into place. Use large vise grips to hold baseplate in place. Then using a 3/8" drill bit, drill hole in frame using baseplate as a template. Do this on both sides of the vehicle.

BX1752  
2022-2023 Chevy Traverse  
(Includes Adaptive Cruise Control & Top Shutters) (No Lower Shutters)  
Installation Instructions



15. Install one (1) 3/8" x 1-1/4" bolt with lock washer and lock nut. Do this on both sides of the vehicle. Remove vise grips.

**\*\* Use Loctite® Red on all bolt threads and tighten all bolts to the appropriate torque.\*\***

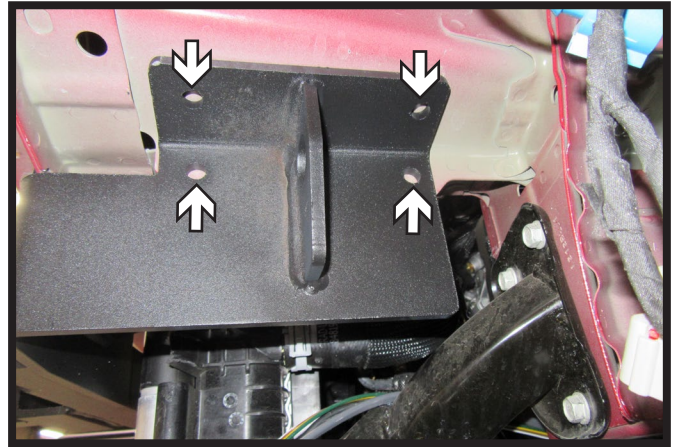

16. Using a 3/8" drill bit, drill the remaining four (4) holes on the side of the vehicle using the baseplate as a template. Do this on both sides of the vehicle.

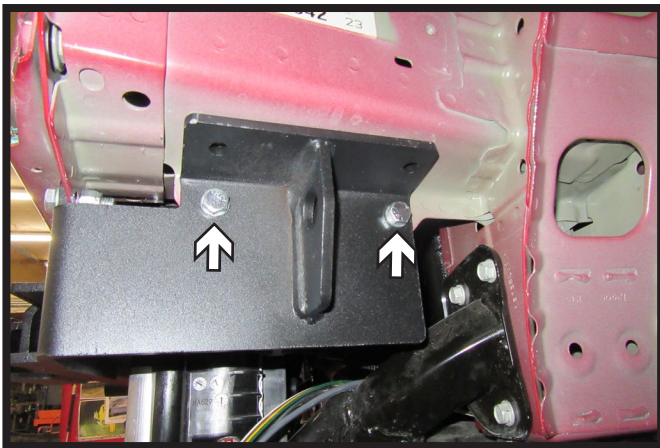

17. Install 3/8" x 1-1/4" bolts with lock washers and lock nuts into bottom two (2) holes. Do this on both sides of the vehicle.

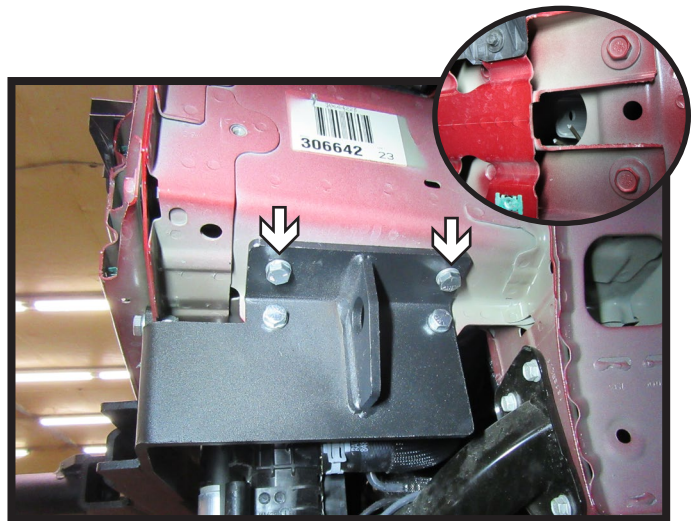

18. Install 3/8" x 1-1/4" bolts with lock washers and nuts plates into top two (2) holes using access hole on front of vehicle (inset). Do this on both sides of the vehicle.

**\*\* Use Loctite® Red on all bolt threads and tighten all bolts to the appropriate torque.\*\***



BX1752  
2022-2023 Chevy Traverse  
(Includes Adaptive Cruise Control & Top Shuttles) (No Lower Shuttles)  
Installation Instructions

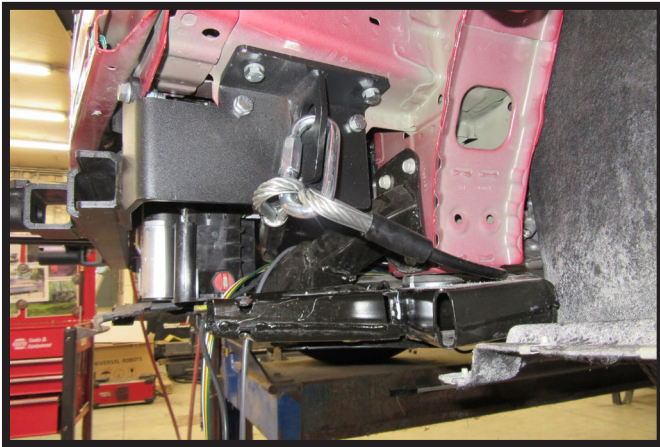

19. Attach the permanent baseplate safety cables to the provided convenience link on the baseplate. The photo above shows the recommended installation of the cables to frame of vehicle. Additional options may interfere with suggested mounting; in this case, secure the cables to a solid piece of the frame as described in the General Information sheet. Be sure the safety cables do not rub against any hoses or moving parts. Do this on **BOTH** sides of the vehicle.

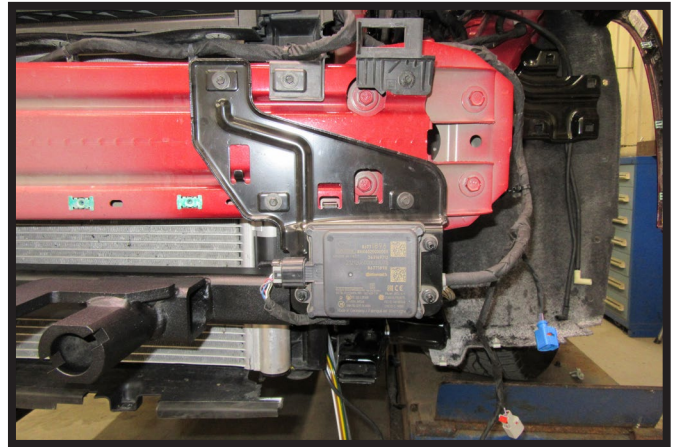

20. Reinstall the ACC bracket on the driver side of the vehicle.

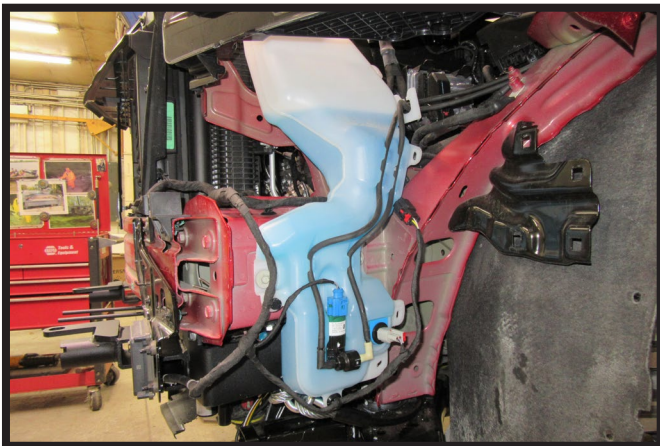

21. Reinstall the windshield washer fluid reservoir on the driver side of the vehicle and reconnect all lines.

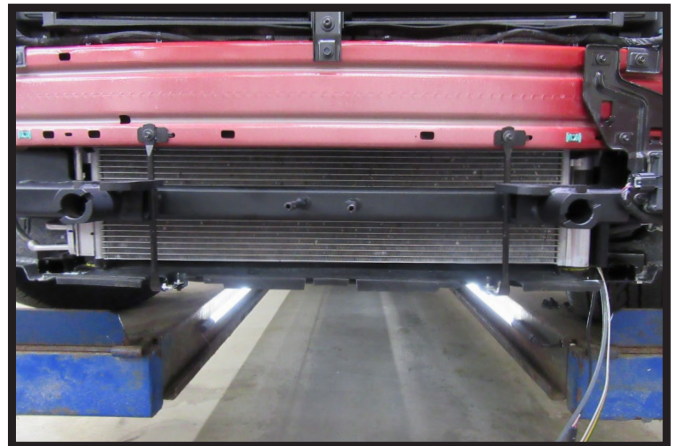

22. Reinstall metal rods to the front of the vehicle.



BX1752  
2022-2023 Chevy Traverse  
(Includes Adaptive Cruise Control & Top Shutters) (No Lower Shutters)  
Installation Instructions



23. Hold the fascia as close to its original position, mark and trim the fascia around the convenience links and attachment tabs. Reinstall the fascia, fascia cover and reconnect all electrical.

## CUSTOMER SERVICE COMMITMENT

Blue Ox® is committed to providing you with exceptional customer care throughout your lifetime with our products. Our team is here to assist you with any questions you may have regarding the performance of your product. Simply call (402) 385-3051 and you can speak with our technical service team.

Additionally, please visit our website to see which rallies our Destination America team will be attending. For a nominal fee, our service technician will service your towing system to ensure it's in proper working condition. Also, as a commitment to our customers, should you visit our factory, you can stay at our full service Blue Ox® campground at no charge along with enjoying a factory tour.

Again, thank you for being our customer and for the confidence you have shown in the performance of our products. It is because of customers like you we enjoy the success we have today.

© 2021 Blue Ox  
One Mill Road, Industrial Park  
Pender, Nebraska 68047  
Phone: (402) 385-3051  
Fax: (402) 385-3360  
[www.blueox.com](http://www.blueox.com)

# General Information

1. Ensure that your product(s) are registered online at [www.blueox.com](http://www.blueox.com). It is crucial to register your product(s) so that you may be alerted of product offerings, updates, upgrades, maintenance and safety bulletins, and/or recalls.
2. **It is the owner's responsibility to inspect all towing equipment for cracked welds, missing or worn parts and loose bolts before each towing trip.** Be sure to use Loctite® Red on all bolts and tighten to the recommended specifications.
3. **It is the owner's responsibility to hook up all towing equipment per manufacturer's instructions/recommendations.**
4. Remove the attachment tabs when not in use (if applicable).

## Notice To Baseplate Installer

### 1. It is YOUR responsibility to watch for:

- Oil cooler and air conditioner lines
- Electrical wires and hoses
- Missing parts or attaching points on the frame

\*\* If the baseplate is improperly installed and is against a wire or hose, it could cause fluid leaks or electrical shorts some time after the actual baseplate installation.

## Permanent Baseplate Safety Cable Installation

Permanent baseplate safety cables are strongly recommended when towing a vehicle with a tow bar. The principle function of the permanent baseplate safety cables is to prevent the towed vehicle from breaking loose in the event the connection between the frame of the towed vehicle and the baseplate fails or becomes disconnected. The cables must be connected from the baseplate to the frame rail or cross member of the vehicle's frame. The illustrations below show the possible arrangements recommended by Blue Ox®. Each permanent baseplate safety cable must have an adequate weight rating for the towing system. The weight rating of the two (2) cables together will not qualify.

***Do not mount the permanent baseplate safety cables against wires, hoses or brake lines.***

These permanent baseplate safety cables should remain installed as long as the baseplate is installed on the vehicle. Permanent baseplate safety cables are to be used in conjunction with, and NOT a replacement for legally required safety cables attaching the towed vehicle to the towing vehicle.

### Option #1

(Baseplates with Convenience Link Tabs)



### Option #2

(Baseplates with out Convenience Link Tabs)



# BLUE OX ORIGINAL PURCHASERS THREE YEAR LIMITED WARRANTY

Automatic Equipment Manufacturing Company ("Automatic") warrants to the original (first) retail purchaser that this product, manufactured by Automatic, shall be free from defect in material and workmanship under normal use and service for a period of three years from the date of delivery.

During said three-year period, Automatic will repair or replace any parts that have been returned by the original purchaser, to the factory, transportation prepaid, and in Automatic's sole and absolute opinion found to be defective.

Limitations on Warranty Coverage:

Coverage under this warranty will be valid only if the customer warranty card is returned by the original purchaser within 30 days of purchase.

Coverage under this warranty will be effective only when a copy of the original invoice, showing date and place of purchase, accompanies any claim for warranty. This warranty is NON TRANSFERABLE.

This limited warranty will not cover, in any way or form, any alleged damages caused by incorrect or improper installation, improper use, modification or neglect of product, failure to properly service and maintain, misuse, act of God, accident or failure of the user to follow guidelines contained in the instructional material provided by Automatic.

This warranty does not cover normal wear and tear, paint or rust.

Warrantor assumes no responsibility to the owner for loss of use of product, loss of time, inconvenience or any other damage consequential or otherwise. Including, but not limited to mileage, expense of transporting of product, return shipping expense, mechanics travel time, telephone, road service, towing, and rental during repairs, travel, lodging, loss or damage to personal property or loss of earnings.

**REPAIR OR REPLACEMENT AS SET FORTH IN THIS LIMITED WARRANTY IS THE SOLE EXCLUSIVE REMEDY OF THE PURCHASER. AUTOMATIC SHALL NOT BE LIABLE FOR ANY INCIDENTAL OR CONSEQUENTIAL DAMAGES FOR BREACH OF ANY EXPRESS OR IMPLIED WARRANTY ON THIS PRODUCT. EXCEPT TO THE EXTENT PROHIBITED BY APPLICABLE LAW, ANY IMPLIED WARRANTY OF MERCHANTABILITY OR FITNESS FOR A PARTICULAR PURPOSE ON THIS PRODUCT IS LIMITED IN LENGTH TO THE DURATION OF THIS WARRANTY.**

Please visit <http://blueox.com/warranty/> to register your warranty



**BLUE OX**